

NuStep[®] T4r

Recumbent Cross Trainer

USER MANUAL



Transforming Lives[®]

Contents

Introduction	4
Safety Instructions.....	5–6
Installation and Placement	7
T4r Feature Overview.....	8
T4r StrideLock®	9
Preparing to Exercise.....	10–11
Console Operation	12–13
Programs.....	14
Console Configuration and System Information	15
Exporting Workout Data and Product Data	16
Preventive Maintenance	17
Serial Number Information	18
Regulatory Information	18
Obtaining Customer Service and Parts.....	19
Warranty Information	19
Replacing Batteries.....	20
Technical Data.....	21
Specifications	22
Safety Notifications.....	23–24
EMC Tables	25–27
US FCC Compliance & IEC/EN 55011 Compliance	28
Intended Purpose and Use.....	29

Introduction

Thank you for purchasing the NuStep® T4r Recumbent Cross Trainer, an innovative product that empowers users to improve cardiovascular and overall fitness.

T4r recumbent cross trainers are suitable for physical therapy, cardiopulmonary rehabilitation, sports medicine and general fitness purposes.



NuStep recumbent cross trainers set an unparalleled standard for total body exercise. By combining a natural sitting position with a smooth stepping motion, the NuStep works all major muscle groups, giving you an effective cardiovascular workout in a comfortable seated position.

The unique design lets you move your arms and legs in a single, dependent, fluid motion that simulates walking, with the added benefit of resistance training. Working the upper and lower body simultaneously uses more muscles and burns more calories.

As the originator of the recumbent cross trainer, NuStep is the leader in developing total body exercise systems that are safe, effective, and easy-to-use. Our products are used in healthcare facilities, wellness centers, and senior living residences around the world, and millions of NuStep users have transformed their lives through exercise – even when they were unable to use other exercise equipment.

Thank you for your business and welcome to our ever-expanding network of NuStep users.

Safety Instructions

	 CAUTION	 WARNING
<p>This is the safety alert symbol. It is used to call attention to instructions concerning personal safety. Read and obey all safety messages that follow this symbol to avoid possible injury or death resulting from misuse.</p>	<p>CAUTION indicates a potentially hazardous situation—which if not avoided—may result in minor or moderate injury. It may also be used to alert against unsafe practices.</p>	<p>WARNING indicates a potentially hazardous situation, which, if not avoided, could result in death or serious injury.</p>

 WARNING
<p>Do not modify this equipment without authorization of the manufacturer.</p> <p>Use this equipment only for its intended use as described in this manual.</p> <p>Do not use attachments not recommended by the manufacturer.</p> <p>Keep product away from heat, sparks, open flames, and hot surfaces.</p> <p>Never drop or insert any object into any opening.</p> <p>Do not use outdoors.</p> <p>Injuries to health may result from incorrect or excessive training.</p> <p>Heart rate monitoring systems may be inaccurate.</p> <p>Over exercising may result in serious injury or death. If you feel faint stop exercising immediately.</p> <p>Use of this equipment adjacent to or stacked with other equipment should be avoided because it could result in improper operation</p> <p>Portable RF communications equipment (including peripherals such as antenna cables and external antennas) should be used no closer than 30 cm (12 inches) to any part of this product, including cables. Otherwise, degradation of the performance of this equipment could result.</p>

Safety Instructions



CAUTION

See your physician before beginning any exercise program.

Supervision is required if you have a disability or medical condition.

Stop exercising if you feel faint or dizzy while using this product, and seek medical help or advice.

Use this product only as directed by your physician if you have heart disease, hypertension, diabetes, respiratory disease, any other medical problem, or if you are pregnant.

People with reduced physical, sensory or cognitive capabilities—or lack of experience and knowledge of this product—may use this product, provided they are supervised by a person responsible for their safety.

Read this manual before using this product and save it for future reference.

Always wear shoes and proper clothing when exercising.

Do not touch or hold product with non-intact skin.

Do not operate this product if it appears damaged or inoperable. Examine product regularly for damage and wear. Ensure defective components are replaced by qualified service technicians immediately.

Do not perform maintenance or repairs on this product while it is in use. Maintenance activities shall be performed by qualified service personnel.



CAUTION

Make sure the seat position and upper arm position are correctly set up for you.

Do not over-extend your arm reach while using this product.

Do not let children use this product.

Do not use this product in the presence of children and/or pets.

Keep children under the age of 13 away from this machine.

The heart rate, watts, METs and calories displays are not suitable for use in applications where the health and safety of the patient is dependent on the accuracy of those parameters.

The maximum user weight capacity for this product is 400 lbs (182 kg).

Do not lift this product by yourself. The T4r is very heavy; it weighs 210 lbs (95 kg).

To avoid injury, or damage to the product, always get assistance to move this product. Use proper lifting techniques.

To avoid injury, do not insert hands in any cover openings.

For safe operation of this product, place on a flat, stable surface. Adjust leveler feet as required.

SAVE THESE INSTRUCTIONS.

Installation and Placement

Carefully unpack the NuStep from the shipping container and transport the product to the installation location.

For recumbent cross trainers shipped in the low profile packaging configuration, reposition and complete installation of the electronics tube in accordance with the provided assembly instructions.

To ensure safe and effective operation of your NuStep, place on a flat, stable surface. Adjust leveler feet as required.

For added stability and floor protection, place the recumbent cross trainer on an exercise equipment floor mat similar to the floor mat sold by NuStep, LLC.

 CAUTION
The T4r is very heavy; it weighs 210 lbs (95 kg).
To avoid injury, or damage to the product, always obtain assistance to move this product.
Use proper lifting technique.

The minimum amount of required free space around the equipment is 24 inches (61 cm) for the sides, and 12 inches (30 cm) for the front and rear. Additional free space is necessary to accommodate wheelchair access.

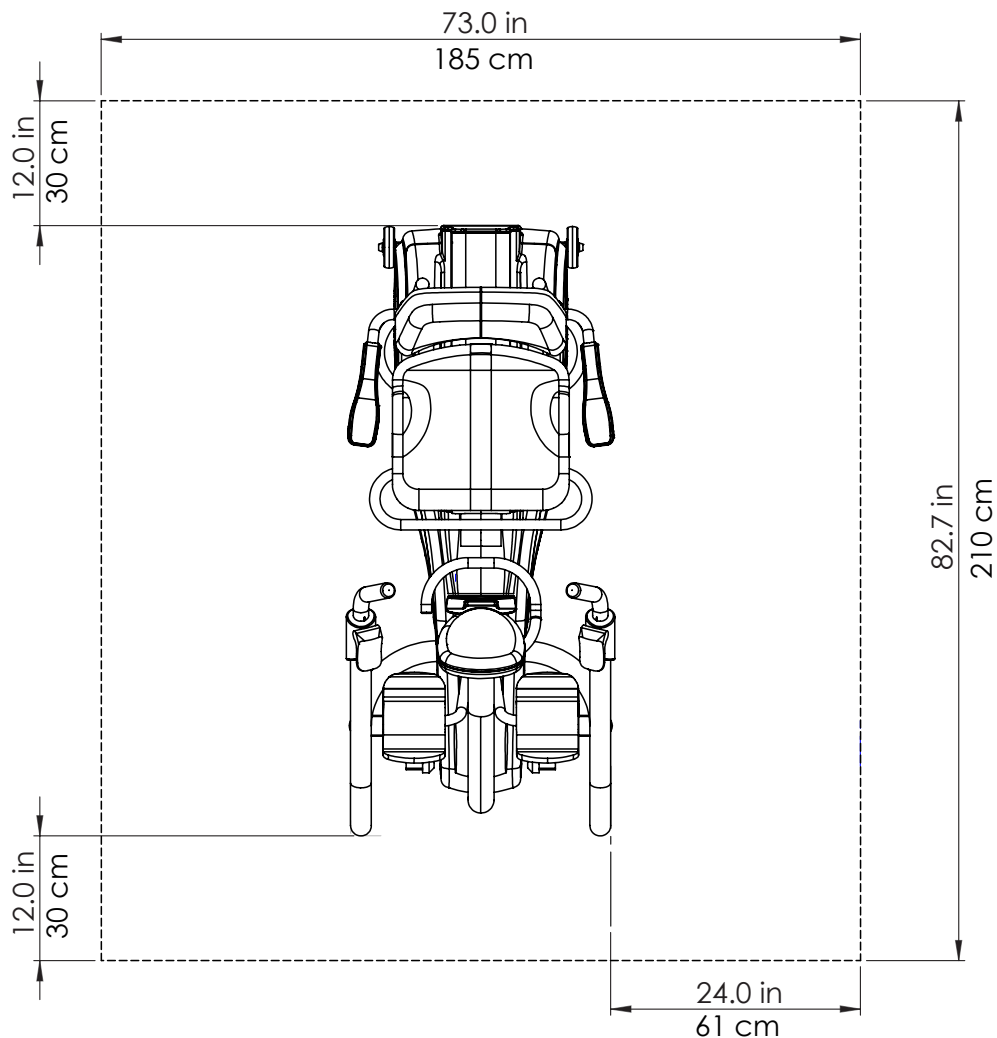

T4r Feature Overview*

* Features vary based on model and options.

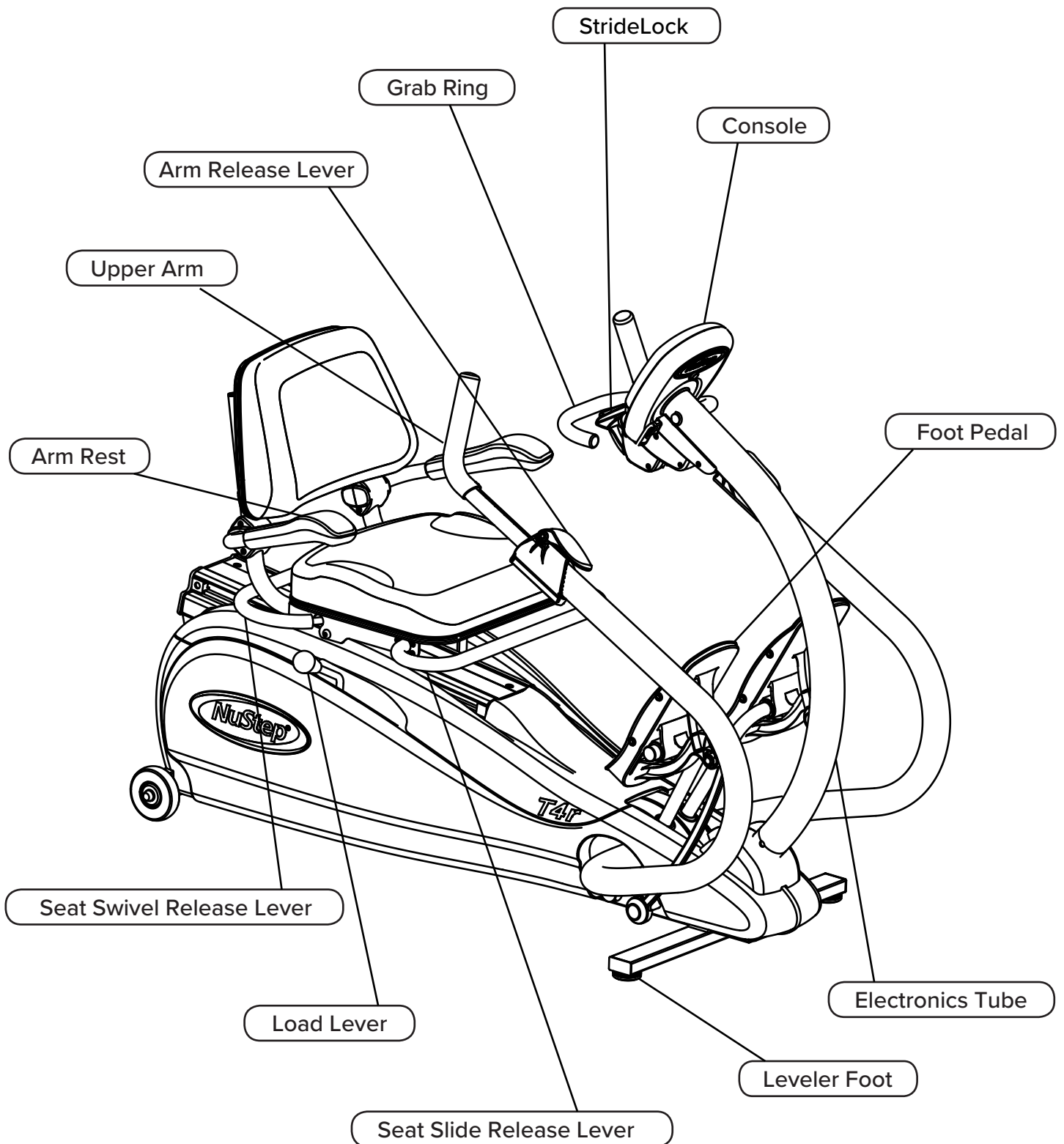

T4r StrideLock[®]*

The NuStep StrideLock feature allows users to lock the arms and pedals of the T4r. Locking the arms and pedals stabilizes the product, making it easier for users to get on and off. Locking the arms and pedals also makes it easier to adjust the seat and upper arms. Use of the StrideLock is recommended when putting on optional adaptive accessories such as the foot secure system and leg stabilizer. (For information about optional accessories, please visit our website, nustep.com.) To use the StrideLock, please follow the below instructions.

1. Place the arms and pedals in the desired position by pushing or pulling one of the upper arm grips.



2. To lock the arms and pedals, push down on the StrideLock lever. Verify that the lock is engaged by pushing or pulling the upper arm grip.

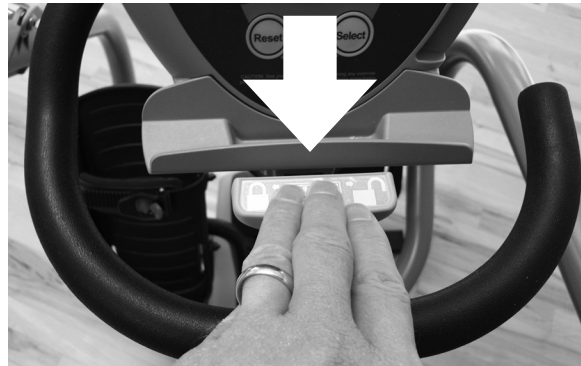

3. To unlock the arms and pedals, push down on the StrideLock lever again.

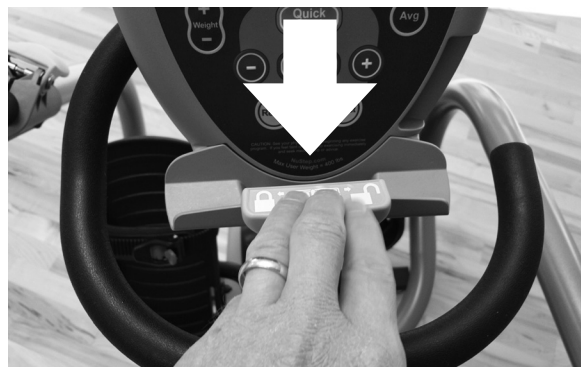

Note: Do not attempt to lock the StrideLock while the arms and pedals are in motion.

*StrideLock is not available on some models.

Preparing to Exercise



Swivel Seat Adjustment

The seat rotates 360° and locks at 45° increments. This provides users with eight convenient positions of access to facilitate easy transfer to the seated position. To swivel the seat, lift up on the swivel release lever directly under the rear and sides of the seat. Swivel the seat left or right until it locks into the desired position. To swivel back to the original forward facing position, lift up on the release lever again. The arm rests lift up and down to allow easier access to the NuStep.

Note: The seat cannot be adjusted forward and back as described in the next section unless the seat is locked in the forward facing position.



Seat Adjustment

The seat position may be adjusted forward and back by lifting up on the seat release lever located directly under the front and sides of the seat. With both feet on the foot pedals, push one foot pedal all the way forward to the end of the pedal range limit. Lift the seat release lever, and slide the seat forward or back until your extended leg has a slight bend at the knee. (Avoid over-extending your legs and/or locking your knees during exercise.)

This position allows your legs to be slightly bent during exercise; avoid over-extending and striking the pedal bumper excessively. Try the motion to verify the position allows for a comfortable exercising motion. If not, slide the seat forward or backward one notch until it feels comfortable. The seat number position appears on the console while the seat is being adjusted.



Arm Adjustment

To adjust the upper arm length, lift the green release lever on the arm. Adjust the upper arm length until your elbow is slightly bent at the extended point of the arm stroke. (For many users, the arm position number matches their seat position number.) Press the green release lever down to lock the upper arm.

CAUTION

Make sure the seat and arm positions are correctly set up before exercising.

Do not over-extend your step or reach distance.

Preparing to Exercise



Workload Adjustment

The workload adjustment lever is located on the right side of the NuStep. To increase workload, push lever forward. To decrease, pull lever backward. The 10 different workload settings appear on the display. The workload is speed dependent, meaning, as you step faster, the resistance increases.



Step Length

The NuStep allows you to determine your own desired range of motion. The maximum step length is approximately 8.5 inches (22 centimeters). For smaller ranges of motion, simply take shorter steps.

Foot Position

The NuStep's stepping action works virtually all leg muscles. Instead of pushing with your whole foot, which works your quadriceps and hamstring muscles, push with the balls of your feet to work your calf muscles.

⚠ CAUTION

This product has arms and pedals that move during operation.

To avoid injury due to contact with these moving parts, use caution while making adjustments during operation.



As shown above, your arm and leg should have a slight bend at the fully extended point of the stroke.

Console Operation

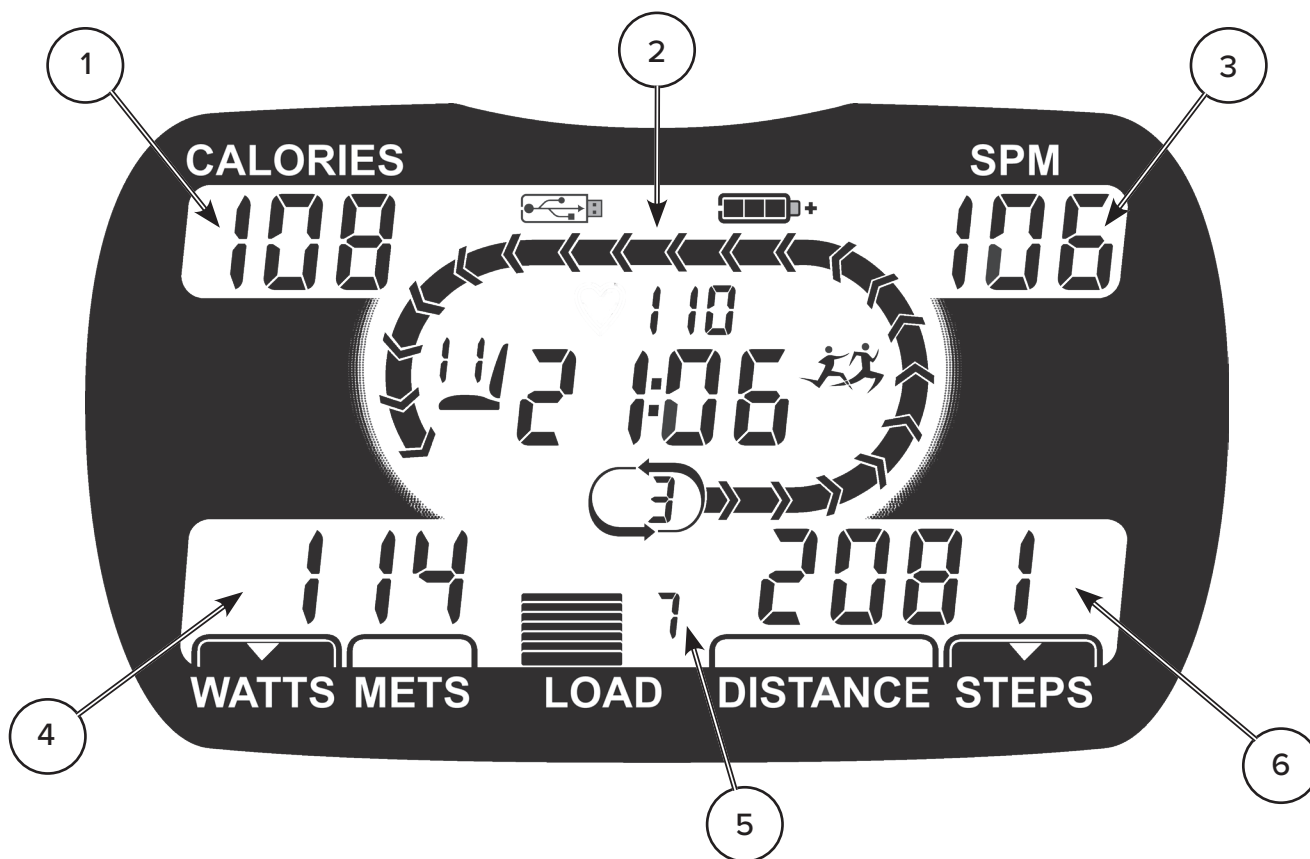

Item Number	Name	Description
1	CALORIES DISPLAY	The quantity of calories burned during the workout is displayed in the CALORIES DISPLAY.
2	MAIN CONSOLE DISPLAY	The following functions are displayed in the MAIN CONSOLE DISPLAY: <ul style="list-style-type: none"> • Workout duration (minutes and seconds) • Battery charge level (during console power up only) • Seat position • Lap progress (track distance is a quarter mile [400 meters]) • Lap counter • Pace partner icon displays if pace partner workout is selected • USB icon displays during data download to flash drive
3	SPM (STEPS PER MINUTE) DISPLAY	The stepping rate is displayed in the SPM DISPLAY.
4	WATTS/METS DISPLAY	Watts or METS are displayed in the WATTS/METS DISPLAY and are an indication of exercise intensity. Use the SELECT button to switch from one display to the other. Watts indicates the amount of energy expended to maintain the workout intensity. METS, an abbreviation for metabolic equivalents, is a unit of measure for expressing the energy cost of physical activity. The MET level of sitting at rest is approximately 1 MET. The METS displayed will increase as the user's exercise intensity increases.
5	LOAD LEVEL DISPLAY	The workload level (1 - 10) is displayed in the LOAD LEVEL DISPLAY. Use the lever below the right side of the seat to increase or decrease load level.
6	DISTANCE/STEPS DISPLAY	The workout distance and total accrued steps are displayed in the DISTANCE/STEPS DISPLAY. Use the SELECT button to switch from one display to the other.

Console Operation

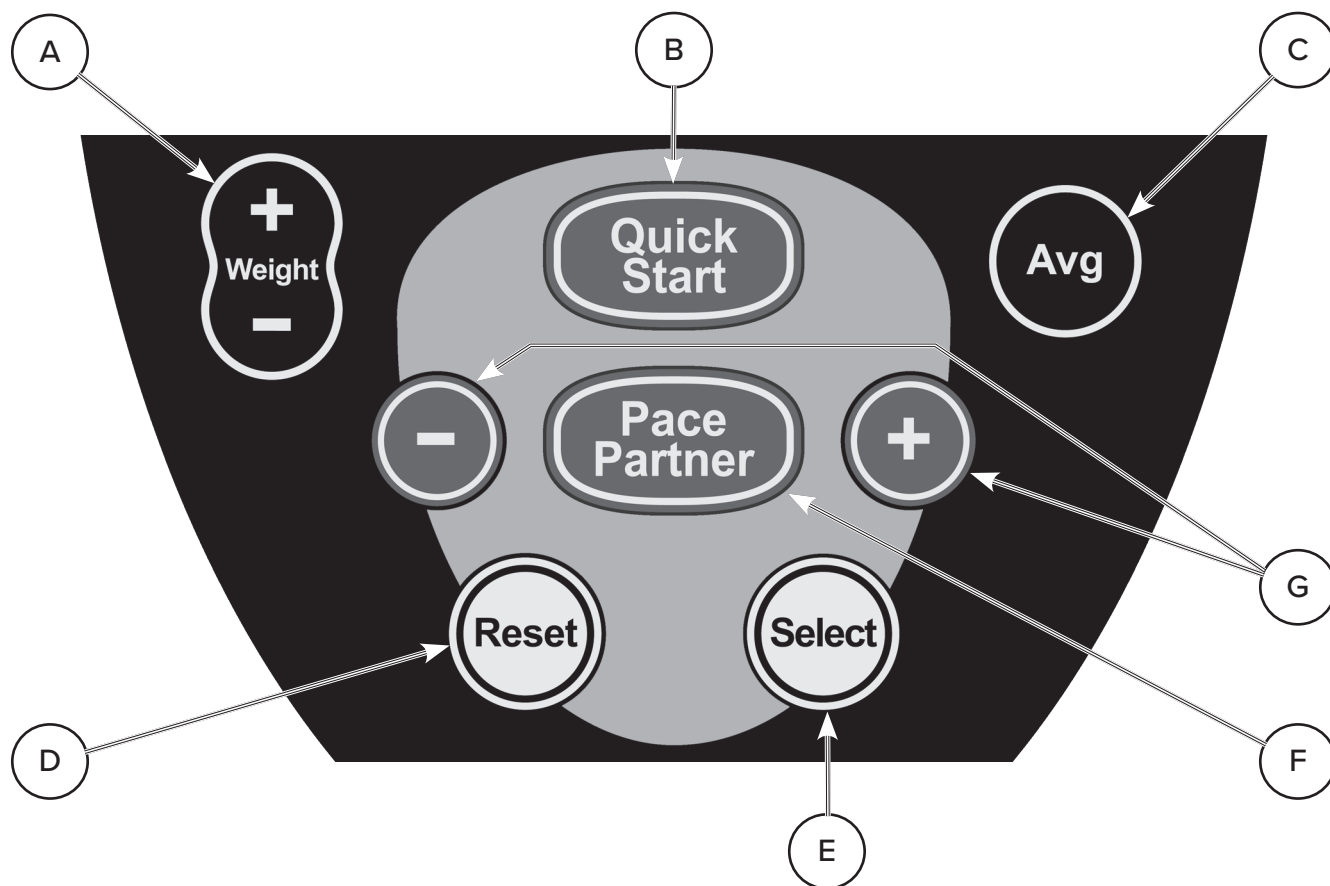

Item Number	Button Name	Description
A	WEIGHT + and WEIGHT -	To enter the user's weight for the exercise session, push (or press and hold) the WEIGHT + or WEIGHT - buttons until the proper weight appears in the main console display, then press the SELECT button. Press and hold the SELECT button to set a new default user weight. Note: Entering user weight increases accuracy of calorie and METS outputs.
B	QUICK START	Press the QUICK START button to immediately start a basic exercise session.
C	AVG	Press the AVG button to display workout averages for steps per minute, watts and METS.
D	RESET	Pressing the RESET button clears the current workout and allows the user to restart.
E	SELECT	The SELECT button has two functions. 1. It allows the user to choose either watts or METS for display in the WATTS/METS DISPLAY, and choose either distance or total cumulative steps in DISTANCE/STEPS DISPLAY. The displayed outputs are indicated with a small triangle in the lower section of the window. 2. The SELECT button is also used to accept an entered parameter (e.g. user weight or steps per minute during pace partner program set up.)
F	PACE PARTNER	The pace partner button and pace partner - and + buttons are used for the pace partner exercise program. Please refer to the programs section of this manual for details on how to use the pace partner exercise program.
G	(PACE PARTNER) - AND +	

Programs

The T4r recumbent cross trainer has two exercise programs, “Quick Start” and “Pace Partner.” After adjusting the seat and upper arms according to the “Preparing to Exercise” section of this manual, choose either the “Quick Start” or “Pace Partner” program. Note: Entering user weight is optional for both programs. However, entering user weight increases the accuracy of calorie and METS outputs. Refer to the “Console Operation” section of this manual for information on entering user weight.

Quick Start

The Quick Start program is a basic program that allows users to start exercising immediately without entering any information into the console. After pressing the QUICK START button, begin stepping and adjust work load as needed. (Note: If the user begins stepping without pressing any console buttons, the QUICK START program will start automatically.)

Pace Partner



This program enables users to more accurately maintain a steady pace by providing a pace partner that is displayed in the main console window. The pace partner is represented by blinking arrow heads that move around the lap track. The goal of the program is for users to consistently match the pace of the pace partner as it moves around the track. During program set up, users may select their preferred Steps Per Minute (SPM) pace.

Press the PACE PARTNER button to begin program set up. The default pace partner pace will appear in the SPM display. To increase or decrease the default SPM pace, press the pace partner - or + buttons until the desired pace displays in the console window then press the SELECT button to complete the program set up. Start stepping and increase your stepping speed so you are able to keep up with your pace partner. During your workout, you may increase or decrease the selected pace by using the - or + buttons.

During your PACE PARTNER workout, the PACE PARTNER icon  will appear in the main console window to indicate that a PACE PARTNER program is selected.

Console Configuration and System Information

Setting Date and Time

To set the console date and time, press the **SELECT** and **AVG** buttons simultaneously. Adjust the fields using the (**PACE PARTNER**) - and + buttons. Use the **SELECT** button to cycle through the fields. Press and hold the **SELECT** button to save the new date and time.

English and Metric Units

Press the **WEIGHT +** or **WEIGHT -** button. The currently configured weight will be displayed along with either an “**LB**” or “**KG**” icon. Simultaneously press the **WEIGHT +** and **WEIGHT -** buttons to switch between English and metric units of measure. To save the change, press and hold **Select** button until icon flashes.

Reset to Factory Defaults

To return the console configuration to factory defaults, press and hold the **RESET** button until the screen goes blank.

View System Information

To view system information for the T4r, press the **SELECT** and **QUICK START** buttons simultaneously. Using the (**PACE PARTNER**) - and/or + buttons, you may cycle through with the following system information screens:

- Date and time
- Total hours of use
- Total hours of Pace Partner program use
- Total number of steps taken
- Total number of file writes to USB flash drive
- Product serial number
- Software boot loader version
- Console software version

Exporting Workout Data and Product Data

Exporting Workout Summary Data

To export a workout summary file, insert flash drive into console USB port and upon completion of workout, press the RESET button. A .csv file will be saved to the root of the flash drive. Wait for the displayed USB symbol to stop blinking before removing the flash drive from the console.

Exporting T4r Product Summary Statistics

To export a product data summary file, insert flash drive into console USB port and press SELECT and WEIGHT - buttons simultaneously. A .txt file will be saved to the root of the flash drive. Wait for the displayed USB symbol to stop blinking before removing the flash drive from the console.

Data Logging

If a flash drive is inserted into the console USB port at the beginning of a workout, a .txt file with incremental workout data will be saved to the flash drive approximately every five minutes. Note: The USB symbol on the console will not appear during the first five minutes of the workout. Thereafter, the USB symbol will appear and will blink when data is being downloaded to the flash drive. To ensure that all workout data is properly downloaded to the flash drive at the end of your workout, do not remove the flash drive from the console until your workout is complete, the workout timer on the main console display has stopped and the USB symbol has stopped blinking.

Preventive Maintenance

Preventive Maintenance Intervals

Although your T4r is designed to be maintenance free, a few tasks are recommended to increase the useful life of the NuStep. Please follow the recommended preventive maintenance intervals according to the amount of usage that the NuStep receives. These are estimated intervals and you may need to increase or decrease the time period between preventive maintenance depending on your actual use.

ITEM	TASK	FREQUENCY
Arm	* Clean	Weekly
Console	* Clean	Weekly
Covers and Frame	* Clean	Weekly
Seat	* Clean	Weekly
* Use a non-abrasive spray cleaner and a soft cloth to clean the NuStep.		

Clinical Settings Note

In clinical settings, patients may operate this equipment in accordance with this user manual and the instructions and guidance provided by the healthcare personnel responsible for supervising their treatment and care. However, patients shall not perform preventive maintenance, repairs or replace batteries on equipment installed in clinical facilities.

T4r Serial Number Information

Location on the product:

The serial number is located on the rear support tube of the main frame.

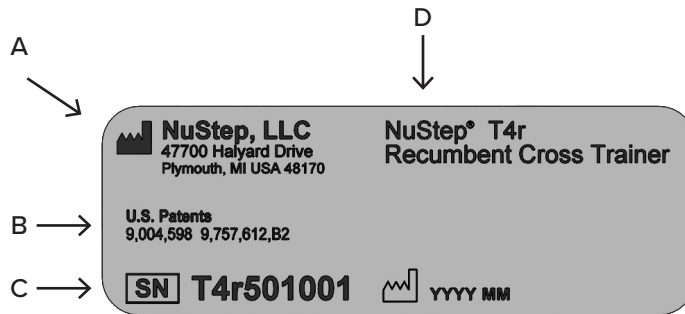

A	Manufacturer's name and address
B	Patent protection for the product
C	Serial number and date of manufacture
D	Model number and description of product

T4r Regulatory Information

Location on the product:

The regulatory information is located on the rear support tube of the main frame.

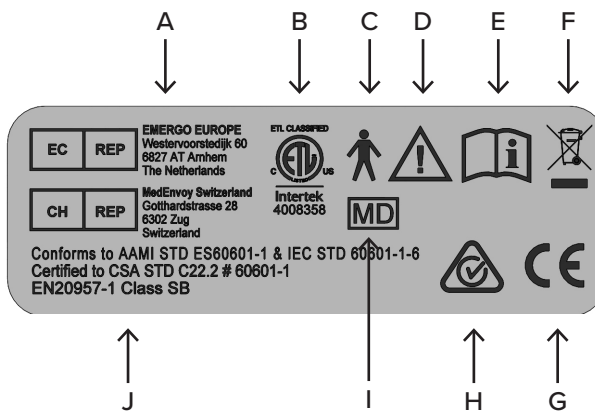

A	European authorized representatives
B	Nationally Recognized Test Lab Mark
C	Type B applied part for electrical safety
D	Attention read accompanying documents
E	Consult the user manual before use
F	WEEE Directive Mark
G	CE Mark
H	RCM
I	Medical device
J	Standards

Label content may vary depending on NuStep model version.

Obtaining Customer Service and Parts

STEP 1 - Identify the problem.

Speak with the person who reported the problem to get a good understanding of the problem.

STEP 2 - Verify the problem.

Inspect the cross trainer, and determine what parts may be required to correct the problem. Figures and parts lists may be obtained from the NuStep, LLC web site or by contacting customer service.

STEP 3 - Contact customer service.

Please have the serial number and a complete description of the problem so our product specialists can better assist you.

Product specialists can be reached via e-mail, phone or fax at:

E-mail: support@nustep.com

Phone: 800.322.2209 or
734.769.3939

Web: NUSTEP.COM

Customers outside the US and Canada, may obtain customer service by contacting their local NuStep distributor.

T4r Warranty

To view your warranty online, go to: NUSTEP.COM

If you have any questions about your warranty, please contact customer service, 800.322.2209 or support@nustep.com.

For international customers, please contact your local distributor for warranty details.

Replacing Console Batteries

Tools Required

Phillips screwdriver

1. Unscrew battery access panel fastener.



2. Replace the 4 AA alkaline batteries. (NiMH rechargeable batteries may also be used.)
Note: Ensure batteries are properly installed



in the correct direction as indicated by battery and polarity symbols in console battery case.

3. Tighten retaining screw and draw the battery cover closed. *Note: The screw will not tighten completely. Just tighten until snug.*



CAUTION

Do not dispose of batteries in a fire. The batteries may explode.

Do not open or mutilate batteries. They contain an electrolyte which is toxic and harmful to the skin and eyes.

Replace batteries with the same number and type of batteries as originally installed in the equipment.

Recycle batteries in accordance with local recycling procedures.

Technical Data

Alkaline Battery	AA batteries, quantity 4, (Energizer EN91) (NuStep part number 41224). Note: If NuStep will not be used for more than three months, remove AA batteries.
USB Port	The T4r console includes a USB host port for data transfer. Note: USB port is for flash drive use only. Some flash drives may not be compatible with the T4r USB port.
Standards	ANSI/AAMI ES60601-1, CAN/CSA-C22.2 No. 60601-1, IEC/EN 60601-1, IEC/EN 60601-1-2, EN 20957-1, EN 957-8 Class SB
Eddy current resistance system	<p>The T4r features a speed dependent eddy current resistance system that is dependent on workload level selected, the user step rate and the user step length.</p> <p>Range 0 - 800 watts</p>
Stepping Action	The T4r features dependent stepping action with up to 8.5” (22 cm) stepping range.
Watts Testing Parameters	Displayed watt values represent the energy consumption rate of the user. They are calculated in real-time utilizing an algorithm based on mechanical parameters of the machine and a measured average ride style. The significant mechanical parameters that influence the displayed watt values include the inertia of the machine’s moving components, the load level selected by the user, and the rotational velocity of the eddy current disk. Validation testing of the displayed watt values was performed by comparing said value and the actual measured mechanical power produced by multiple users. Displayed watt values are independent of any physiological or anatomical parameter possessed by the user.

Specifications

Dimensions and Weight

- Length: 60" (152 cm)
- Width: 27" (69 cm)
- Height: 45" (115 cm)
- Weight: 210 lbs (95 kg)

User Height and Weight Limits

- Height: 4'6" to 6'4" (137 cm to 193 cm)
- Weight: 400 lbs (182 kg)

 **CAUTION**

The maximum user weight limit for this product is 400 lbs (182 kg).

Overview

- Total body conditioning of the cardiovascular and muscular systems.
- Use arms alone, legs alone, or both.
- Closed-kinetic chain exercise.
- Low 9.5"–13.5" step-through height for easy access.
- Biomechanically correct workout position.
- Contralateral movement – arm linked with opposite leg.
- Smooth, fully connected motion between arms and legs.
- User-controlled step length of up to 8.5" (22 cm).

Resistance System

- Quiet, frictionless, permanent magnetic eddy current system with 10 workload levels.
- User power output from 0–800 watts.
- All-belt drive.
- Long-life, high-grade bearings.

Frame

- Durable, heavy-duty welded steel frame.
- Powder-coated frame and zinc-plated components resist rust.
- Four-point contact with the floor and leveling feet increase stability.
- Strong, impact-resistant polystyrene cover is easy to clean.
- Anodized aluminum arms with extra-long, comfortable hand grips.
- Long, 15" (38 cm) arm adjustment range.
- Lift unit with front handle and roll on rear wheels or use optional NuStep transporter device.

 **CAUTION**

The T4r is very heavy; it weighs 210 lbs (95 kg).

To avoid injury, or damage to the product, always obtain assistance to move this product.

Use proper lifting technique.

Seat and Arm Rests

- Swivel seat rotates 360° and locks at 45° increments.
- Foam padded seat and swivel release levers operate from center or sides.
- Seat slides and adjusts smoothly.

- 15" (38 cm) forward/backward seat adjustment range.
- Ergonomically designed padded seat has contoured back support.

Display

- Simple, one-button quick start and reset; automatic power on/off.
- Easy-to-read display shows:

SPM: 5–210

Watts: 0–800

METS: 2–24

Time: Accrues from 0:00

Steps: Step count accrues up to 9,999 steps

Distance: MI or Km

Load levels: 10 load levels

Calories: Up to 999 KCal

Seat Position: 1-15

- User selects English or metric measurement system.
- Cordless design uses 4 AA alkaline batteries (NiMH rechargeable batteries may also be used).
- USB port for data download.

Foot Pedals



- Pedals are made of durable molded plastic.
- Four-bar linkage and nonskid tread keep feet secure.

For information about optional accessories, please visit our website, nustep.com.

Safety Notifications

TYPE / DEGREE OF PROTECTION	CLASSIFICATION / IDENTIFICATION/ WARNINGS	SYMBOL
Type of protection against electric shock	Internally Powered Equipment	NA
The degree of protection against electric shock	Type B applied part	
The degree of protection against the ingress of liquids	Not protected	NA
The degree of safety in the presence of a flammable anesthetic mixture with air or with oxygen or nitrous oxide	Not suitable	NA
The mode of operation	Continuous	NA
Information regarding potential electromagnetic or other interference and advice regarding avoidance	The NuStep® T4r Recumbent Cross Trainers use electromagnetic and RF energy only for its internal function. Therefore, its EMC and RF emissions are very low and are not likely to cause any interference in nearby electronic equipment.	NA
EMC warnings and tables required by IEC 60601 -1 -2	See EMC tables.	NA

Safety Notifications

TYPE / DEGREE OF PROTECTION	CLASSIFICATION / IDENTIFICATION / WARNINGS	SYMBOL
ID of any risks associated with the disposal of waste products, residues, including disposal of the equipment itself at the end of its useful life.	The NuStep® T4r Recumbent Cross Trainer equipment contains electronic circuit assemblies and alkaline batteries that may require compliance with specific local disposal or recycling procedures.	 
The specification of the environmental conditions of transport and storage (also marked on the outside of the packaging).	<p>The NuStep® T4r Recumbent Cross Trainer equipment can be:</p> <p>a) safely transported and stored in these conditions -10° to 50°C; ≤ 95% non-condensing humidity; 20 to 107 kPa</p> <p>b) operated in these conditions 5° to 40°C; ≤ 85% non-condensing humidity; 60 to 107 kPa.</p>	NA
Indication that the equipment is energized.	No such indicator provided.	NA
Indication of long term battery storage	If the NuStep® T4r Recumbent Cross Trainer equipment will not be used for longer than 3 months, please remove batteries.	NA

EMC Tables

Guidance and manufacturer's declaration – electromagnetic emissions		
<p>The NuStep model T4r is intended for use in the electromagnetic environment specified below. The customer or the user of the NuStep model T4r should assure that it is used in such an environment. The product does not include essential performance features and functions.</p>		
Emissions test	Compliance	Electromagnetic environment – guidance
RF emissions CISPR 11	Group 1	<p>The NuStep model T4r uses RF energy only for its internal function. Therefore, its RF emissions are very low and are not likely to cause any interference in nearby electronic equipment.</p> <p>The NuStep model T4r is suitable for use in all establishments, including domestic establishments and those directly connected to the public low voltage power supply network that supplies buildings used for domestic purposes.</p>
RF emissions CISPR 11	Class B	
Harmonic emissions IEC 61000-3-2	Not applicable	
Voltage fluctuations/ flicker emissions IEC 61000-3-3	Not applicable	

EMC Tables

Table 2 – Guidance and MANUFACTURER’S declaration – electromagnetic IMMUNITY – for all ME EQUIPMENT and ME SYSTEMS

Guidance and manufacturer’s declaration – electromagnetic immunity			
The NuStep model T4r is intended for use in the electromagnetic environment specified below. The customer or the user of the NuStep model T4r should assure that it is used in such an environment.			
IMMUNITY test	IEC 60601 test level	Compliance level	Electromagnetic environment – guidance
Electrostatic discharge (ESD) IEC 61000-4-2	± 8 kV contact ± 15 kV air	± 6 kV contact ± 8 kV air (See note 1)	Floors should be wood, concrete or ceramic tile. If floors are covered with synthetic material, the relative humidity should be at least 30 %.
Electrical fast transient/burst IEC 61000-4-4	± 2kV for power supply lines	Not applicable	Not applicable
Surge IEC 61000-4-5	± 1 kV differential mode ± 2 kV common mode	Not applicable	Not applicable
Voltage dips, short interruptions and voltage variations on power supply input lines IEC 61000-4-11	0 % UT; 0,5 cycle 0 % UT; 1 cycle 70 % UT; 25/30 cycles 0 % UT; 250/300 cycle	Not applicable	Not applicable
Power frequency (50/60 Hz) magnetic field IEC 61000-4-8	30 A/m	30 A/m	Power frequency magnetic fields should be at levels characteristic of a typical location in a typical commercial or hospital environment
NOTE 1 Higher levels of ESD will have no impact upon basic safety or essential performance. (See: Guidance and manufacturer’s declaration – electromagnetic emissions)			

EMC Tables

Table 3 – Guidance and MANUFACTURER’S declaration – electromagnetic IMMUNITY – for ME EQUIPMENT and ME SYSTEMS that are not LIFE-SUPPORTING

Guidance and manufacturer’s declaration – electromagnetic immunity			
The NuStep model T4r is intended for use in the electromagnetic environment specified below. The customer or the user of the NuStep model T4r should assure that it is used in such an environment.			
IMMUNITY test	IEC 60601 TEST LEVEL	Compliance level	Electromagnetic environment – guidance
<p>Conducted RF IEC 61000-4-6</p> <p>Radiated RF IEC 61000-4-3</p>	<p>3 Vrms 150 kHz to 80 MHz</p> <p>3 V/m 80 MHz to 2,7 GHz</p>	<p>Not applicable</p> <p>3 V/m</p>	<p>Portable and mobile RF communications equipment should be used no closer to any part of the NuStep model T4r, including cables, than the recommended separation distance calculated from the equation applicable to the frequency of the transmitter.</p> <p>Recommended separation distance</p> <p>Not applicable</p> <p>$d = 1.2\sqrt{P}$ 80 MHz to 800 MHz</p> <p>$d = 2.3\sqrt{P}$ 800 MHz to 2,7 GHz</p> <p>Where P is the maximum output power rating of the transmitter in watts (W) according to the transmitter manufacturer and d is the recommended separation distance in meters (m). Field strengths from fixed RF transmitters, as determined by an electromagnetic site survey, ^a should be less than the compliance level in each frequency range. ^b</p> <p>Interference may occur in the vicinity of equipment marked with the following symbol:</p> 
<p>NOTE 1 At 80 MHz and 800 MHz, the higher frequency range applies.</p> <p>NOTE 2 These guidelines may not apply in all situations. Electromagnetic propagation is affected by absorption and reflection from structures, objects and people.</p> <p>NOTE 3 The product complies with IEC 60601-1-2 clause 8.10 table 9 for immunity to proximity fields from RF wireless communications equipment</p>			
<p>a. Field strengths from fixed transmitters, such as base stations for radio (cellular/cordless) telephones and land mobile radios, amateur radio, AM and FM radio broadcast and TV broadcast cannot be predicted theoretically with accuracy. To assess the electromagnetic environment due to fixed RF transmitters, an electromagnetic site survey should be considered. If the measured field strength in the location in which the NuStep model T4r is used exceeds the applicable RF compliance level above, the NuStep model T4r should be observed to verify normal operation. If abnormal performance is observed, additional measures may be necessary, such as re-orienting or relocating the NuStep model T4r.</p> <p>b. Over the frequency range 150 kHz to 80 MHz, field strengths should be less than 3 V/m.</p>			

US FCC Compliance & IEC/EN 55011 Compliance

US FCC Compliance Statement:

Note: This equipment has been tested and found to comply with the limits for a Class B Digital Device, pursuant to Part 15 of the FCC Rules. These limits are designed to provide reasonable protection against harmful interference in a residential installation. This equipment generates, uses and can generate radio frequency energy and, if not installed and used in accordance with the installation instructions, may cause harmful interference to radio communications. However, there is no guarantee that interference may not occur in a particular installation. If the equipment causes harmful interference to radio or television reception, which can be determined by turning this equipment off and on, the user is encouraged to try and correct the interference by one or more of the following measures:

- Reorient or relocate the receiving antenna.
- Increase the separation between the equipment and the receiver.

Consult the dealer or an experienced radio/TV technician for help.

Changes or modifications not expressly approved by the party responsible for compliance could void the user's authority to operate the equipment

IEC/EN 55011 Compliance Statement:

This device complies with IEC/EN 55011, Group 1, Class B. Group 1 contains all ISM equipment in which there is intentionally generated and/or used conductively coupled radio-frequency energy which is necessary for the internal functioning of the equipment itself. Class B equipment is suitable for use in domestic establishments and in establishments directly connected to the low voltage power supply network which supplies buildings used for domestic purposes.

Trademarks

The Bluetooth® word mark and logos are registered trademarks owned by the Bluetooth SIG, Inc. and any use of such marks by NuStep,LLC is under license. Other trademarks and trade names are those of their respective owners.

Intended Purpose and Use

Intended Purpose

The NuStep® recumbent cross trainer is an apparatus for therapeutic exercise.

Intended Use

The recumbent cross trainer may be used to improve aerobic fitness, strength and endurance. The recumbent cross trainer includes the following features and functionality to assist individuals who have mobility or cognitive impairments:

- swivel seat
- arm rests
- StrideLock®
- stabilization straps
- seated exercise position
- contralateral exercise motion

Under the guidance and supervision of a physician and/or a physical therapist, the recumbent cross trainer may be used by cardiac, cardiovascular, and physical therapy patients for therapeutic exercise. The physician and/or physical therapist responsible for the patient's care shall assess the benefits and risks of using the recumbent cross trainer for therapeutic exercise prior to each use to ensure that the chosen form of use is appropriate and reasonable.

Intended Operator

The intended operators are qualified healthcare professionals who have been trained on the information provided in the recumbent cross trainer user manual. The patient or exerciser is not the intended operator, but the intended operator may allow the patient or exerciser to operate the recumbent cross trainer according the instructions in the product user manual. The operation of the recumbent cross trainer remains the responsibility of the intended operator at all times.

Intended Location

The recumbent cross trainer is suitable for use in the following settings:

- physical therapy clinics
- cardiopulmonary rehabilitation clinics
- sports medicine clinics
- general wellness centers



EMERGO EUROPE
Westervoortsedijk 60,
6827 AT Arnhem
The Netherlands

Note:

Any serious incident that has occurred in relation this product should be reported to NuStep, LLC, the above listed European Authorized Representative, and the EU competent authority of the member state in which the user is established. The expected service life of this product is ten years.

NuStep, LLC
47700 Halyard Drive
Plymouth, MI 48170
USA
800.322.2209
734.769.3939
NUSTEP.COM



The information in this manual is the most current at the time of printing. Due to our commitment toward continuous improvement, specifications and descriptions are subject to change without notice. No part of this manual may be reproduced or transmitted in any form or by any means, electronic or mechanical, for any purpose without the express written permission of NuStep. © Copyright July 2021 by NuStep.

NuStep® and Transforming Lives® are registered trademarks of NuStep, LLC.

Manual PN 45500-01 T4r User Manual, Rev J

