

NuStep[®] T6

Recumbent Cross Trainer

USER MANUAL



Transforming Lives[®]

Contents

Introduction.....	4
Safety Instructions.....	5–6
Installation and Placement.....	7
AC Adapter Use.....	8
T6 Feature Overview	9
T6 StrideLock®	10
Making Adjustments.....	11–13
Correct Riding Position.....	13
Display Screens.....	14–16
Pause Function	17
System Settings.....	18–19
User Settings.....	20
Exporting User Profile Data.....	21
Exporting Workout Summary	22
Preventive Maintenance.....	23
Serial Number Information.....	24
T6 Regulatory Information	24
Obtaining Customer Service and Parts	25
T6 Warranty Information.....	25
Technical Data.....	26
Safety Notifications.....	27–28
EMC Tables	29–31
US FCC Compliance & IEC/EN 55011 Compliance.....	32
Intended Purpose and Use.....	33

Introduction



Thank you for purchasing the NuStep T6 Recumbent Cross Trainer.

As the originator of the recumbent cross trainer, NuStep is the leader in developing seated total-body exercise systems that are inclusive, effective and easy-to-use. Our products are used in healthcare settings, wellness centers, and senior living communities worldwide.

The T6 marks a milestone in NuStep's continuous pursuit of advancement, customer satisfaction and best-in-class quality. As a customer-focused company, NuStep turned to our customers, including healthcare professionals, and fitness experts for insight on what features to include in the product. The T6 is the end-result of this valuable feedback.

Thank you for your business and welcome to our ever-expanding network of NuStep users.

Safety Instructions

	 CAUTION	 WARNING
<p>This is the safety alert symbol. It is used to call attention to instructions concerning personal safety. Read and obey all safety messages that follow this symbol to avoid possible injury or death resulting from misuse.</p>	<p>CAUTION indicates a potentially hazardous situation—which if not avoided— may result in minor or moderate injury. It may also be used to alert against unsafe practices.</p>	<p>WARNING indicates a potentially hazardous situation, which, if not avoided, could result in death or serious injury.</p>

 WARNING
<p>Do not modify this equipment without authorization of the manufacturer.</p> <p>Use this equipment only for its intended use as described in this manual.</p> <p>Do not use attachments not recommended by the manufacturer.</p> <p>Never operate this equipment if it has a damaged cord or plug.</p> <p>Keep cord away from heated surfaces.</p> <p>Keep product away from heat, sparks, open flames, and hot surfaces.</p> <p>Never drop or insert any object into any opening.</p> <p>Do not use outdoors.</p> <p>Injuries to health may result from incorrect or excessive training.</p> <p>Heart rate monitoring systems may be inaccurate.</p> <p>Over exercising may result in serious injury or death. If you feel faint stop exercising immediately.</p> <p>Use of this equipment adjacent to or stacked with other equipment should be avoided because it could result in improper operation.</p> <p>Portable RF communications equipment (including peripherals such as antenna cables and external antennas) should be used no closer than 30 cm (12 inches) to any part of this product, including cables. Otherwise, degradation of the performance of this equipment could result.</p>

Safety Instructions



CAUTION

See your physician before beginning any exercise program.

Supervision is required if you have a disability or medical condition.

Stop exercising if you feel faint or dizzy while using this product, and seek medical help or advice.

Use this product only as directed by your physician if you have heart disease, hypertension, diabetes, respiratory disease, any other medical problem, or if you are pregnant.

People with reduced physical, sensory or cognitive capabilities—or lack of experience and knowledge of this product—may use this product, provided they are supervised by a person responsible for their safety.

Read this manual before using this product and save it for future reference.

Always wear shoes and proper clothing when exercising.

Do not touch or hold product with non-intact skin.

Do not operate this product if it appears damaged or inoperable. Examine product regularly for damage and wear. Ensure defective components are replaced by qualified service technicians immediately.

Do not perform maintenance or repairs on this product while it is in use. Maintenance activities shall be performed by qualified service personnel.



CAUTION

Make sure the seat position and upper arm position are correctly set up for you.

Do not over-extend your arm reach while using this product.

Do not let children use this product.

Do not use this product in the presence of children and/or pets.

Keep children under the age of 13 away from this machine.

The heart rate, watts, METs and calories displays are not suitable for use in applications where the health and safety of the patient is dependent on the accuracy of those parameters.

The maximum user weight capacity:
T6_{PRO} model = 500 lbs (227 kg)
T6_{MAX} model = 600 lbs (272 kg)

Do not lift this product by yourself. The T6 is very heavy; it weighs 298 lbs (135 kg).

To avoid injury, or damage to the product, always get assistance to move this product. Use proper lifting techniques.

To avoid injury, do not insert hands in any cover openings.

For safe operation of this product, place on a flat, stable surface. Adjust leveler feet as required.

This product is intended to be connected to AC mains power through the furnished AC adapter only.

SAVE THESE INSTRUCTIONS.

Installation and Placement

Unpacking and Installation

Unpacking and installation procedures for T6 shipments are documented in the applicable T6 delivery installation guideline documents. The installation guideline documents are shipped with the products. Additional copies of these documents are available upon request from customer service.

Placement of Equipment

To ensure safe and effective operation of your NuStep, place on a flat, stable surface. Adjust rear leveler feet as required.

The minimum amount of required free space around the equipment is 24 inches (61 cm) for the sides, and 12 inches (30 cm) for the front and rear. Additional free space is necessary to accommodate wheelchair access.

For added stability and floor protection, place the recumbent cross trainer on an exercise equipment floor mat similar to the floor mat sold by NuStep, LLC.

CAUTION

The T6 is very heavy; it weighs 298 lbs (135 kg).

To avoid injury, or damage to the product, always obtain assistance to move this product.

Use proper lifting technique.

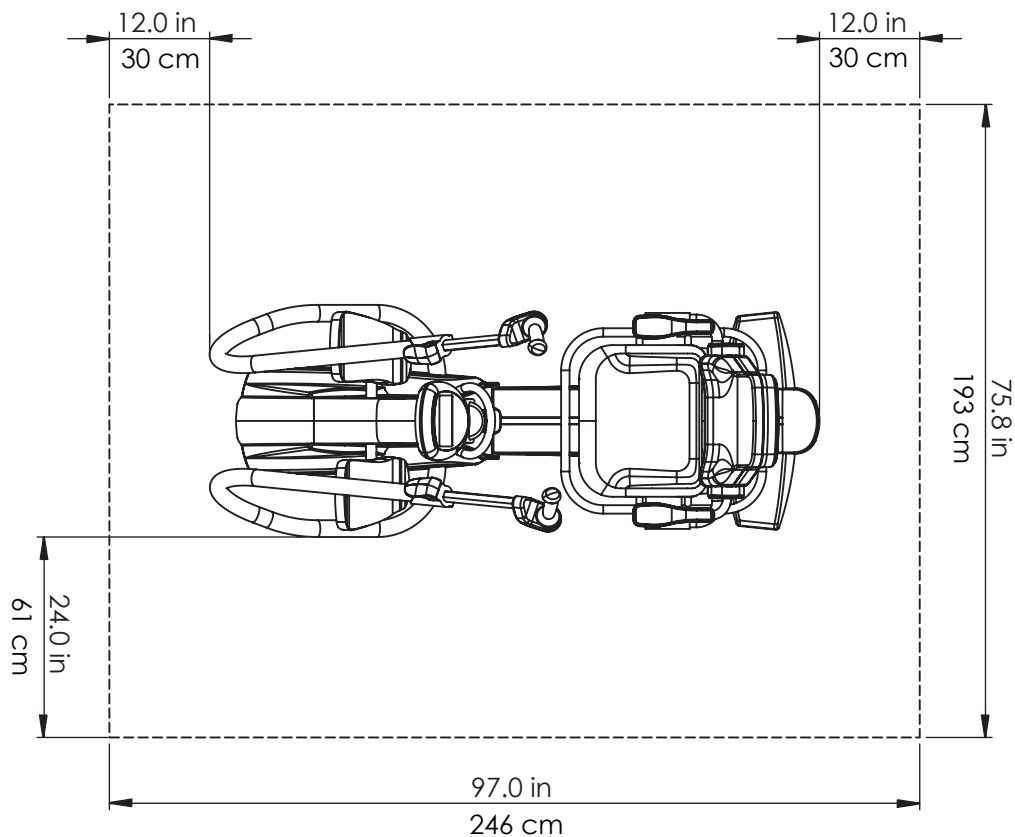

AC Adapter Use

The T6 is powered by an AC adapter which is included with the equipment. The AC adapter may be plugged into either the front or the rear jack.* Plug the adapter into an appropriate power outlet.

Route the AC adapter power cable in a manner that prevents tripping hazards and prevents damage to the adapter. Avoid placing any pressure or strain on adapter cables, jacks or plugs.

For adapter specifications, please refer to the Technical Data section of this manual.

**Do not connect the T6 to two AC adapters simultaneously.*

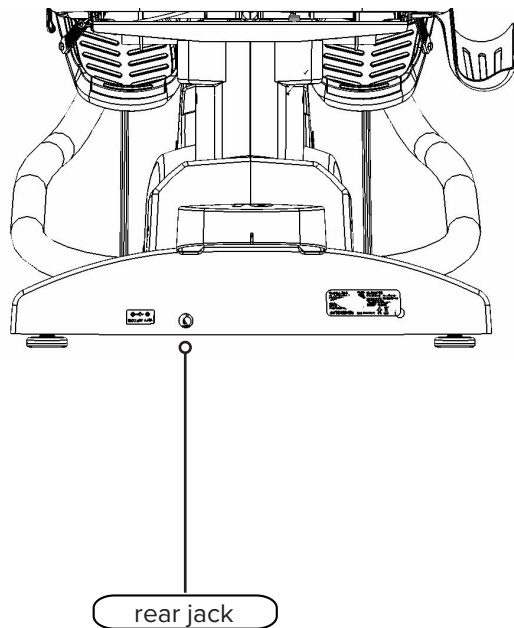
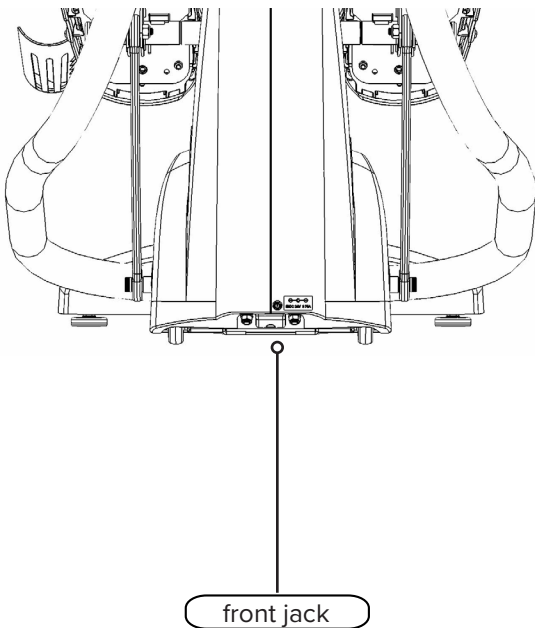
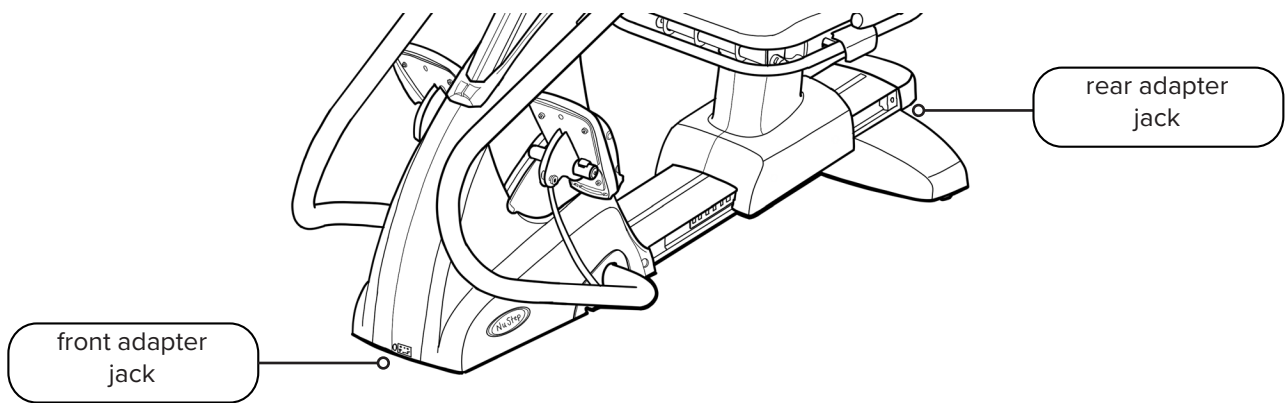

T6 Feature Overview

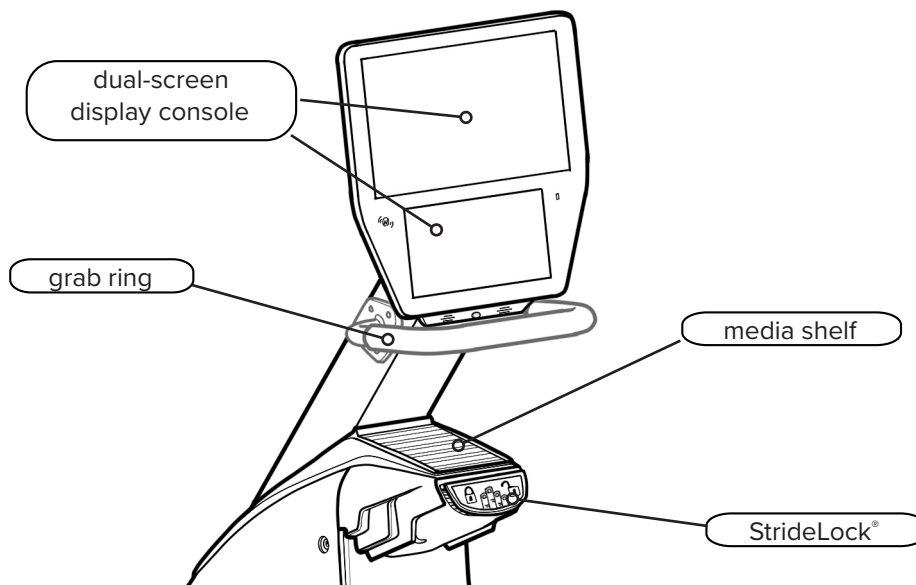
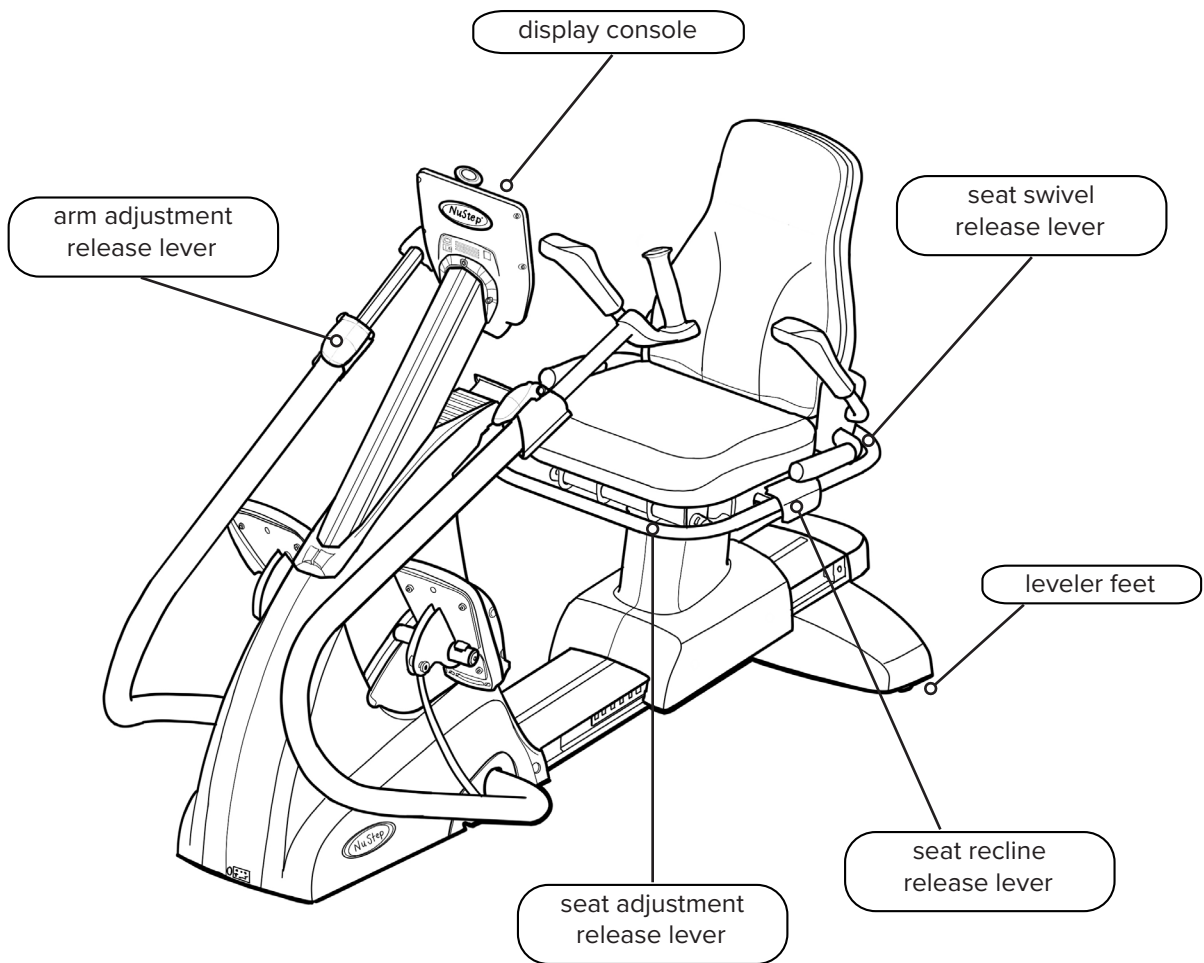

T6 StrideLock®

The StrideLock feature allows users to lock the arm handles and foot pedals on the T6. When StrideLock is engaged, the handles and pedals do not move. This stabilizes the product and makes it easier for the user to:

- Get on and off the T6
- Adjust seat and handle positions
- Fasten footstraps or attach adaptive accessories



StrideLock lever

To engage StrideLock:

1. Use the arm handles to push or pull the arms and pedals to the desired position.
2. Push down on the yellow StrideLock lever and release. The lever is **UP** when **locked**.
3. Confirm StrideLock is engaged by pushing or pulling on the arm handles—they should not move.



Lever is up when handles and pedals are locked.

To disengage StrideLock:

1. Push down on the StrideLock lever again. The lever is **DOWN** when **unlocked**.



Lever is down when handles and pedals are unlocked.

Making Adjustments

Adjust Seat Distance

1. Lift the front yellow lever to unlock.
2. Using feet, slide seat forward or backward to adjust distance.
3. Check that knee has a slight bend when leg is nearly fully extended.
4. Release lever to lock seat in place.



Lift front lever to adjust seat distance.



Knee has slight bend when leg is nearly fully extended.

Adjust Seat Recline

1. Place feet on pedals.
2. Lift the black lever on left side to unlock.
3. Push on seat back to increase recline (up to 12° recline possible).
4. Release lever to lock seat in place.



Lift black lever on left side.



Push on seat back to adjust recline angle.

Making Adjustments

Adjust Handle Length

1. Pull up on the yellow arm adjustment release lever to unlock arm handles.
2. Slide handle in or out to adjust length.
3. Adjust handles until elbow is slightly bent when arm is almost fully extended (for many people this is the same number as their seat position).
4. Press release lever down to lock.



Pull up on lever to unlock.



Push down on lever to lock.

Adjust Arm Rotation

1. Pull up on the yellow arm adjustment release lever to unlock.
2. Rotate the hand grip right or left.
3. Once set, press the release lever down to lock.



Making Adjustments

Swivel Seat Operation

1. Lift the rear release lever to unlock seat.
2. Swivel the seat in either direction (seat swivels 360° and locks every 45°).
3. Release the lever to lock seat in position.

NOTE: The seat can be rotated with or without a user on the machine. For safety, the seat distance cannot be adjusted unless it is facing forward.



Lift rear lever to unlock seat.



Seat swivels 360° in either direction and locks in place every 45°.

Correct Riding Position

After adjusting the arm handles and seat position on the T6, there should be a *slight* bend in your knees and elbows at nearly full extension when exercising on your T6.

	CAUTION
Injuries to health may result from incorrect or excessive use.	
Ensure the seat and arms are set up in biomechanically correct positions.	
Do not over-extend your leg or arm reach distance.	

Elbow has slight bend when arm is nearly fully extended.



Knee has slight bend when leg is nearly fully extended.

Display Screens

The T6 has a Home screen and Metric screen with touchscreen navigation:

Home screen: Displays icons for *Quick Start*, *Pace Partner*, *NuStep Charts*, and *Trail Runner*. Tap icon to launch.

Metric screen: Displays all workout metrics including *Elapsed Time*, *Level (resistance)*, *Heart Rate*, *Calories*, *SPM (steps per minute)*, *METs*, *Total Steps*, *Miles*, and *Watts*.



App Screens

Quick Start

Lets users to get on and go without setting pace goals or selecting metric values. Tracks elapsed time and total laps.

Users can switch to other apps from the *Quick Start* screen. To switch:

1. Tap [See Your Chart →](#) to open *Performance Charts*.
2. Tap [Keep Your Pace →](#) to open *Pace Partner*.

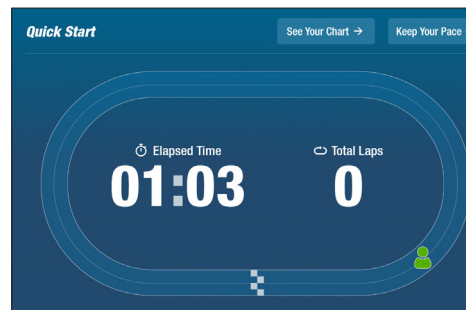

Display Screens

Pace Partner

Users set a target pace and select a workout metric (*SPM*, *Watts* or *METs*) with the goal to keep pace with the targeted pace. To set:

1. Tap **Set Your Target** to open *Your Target Pace* screen.
2. Tap on desired metric.
3. Use slider to select pace.
4. Tap *Confirm* to set.

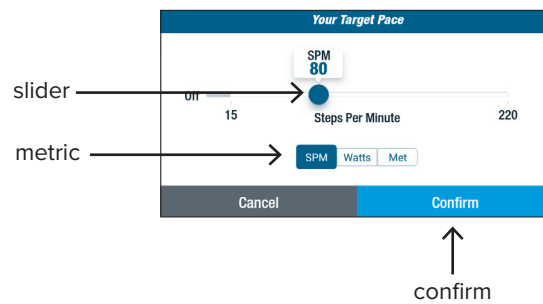
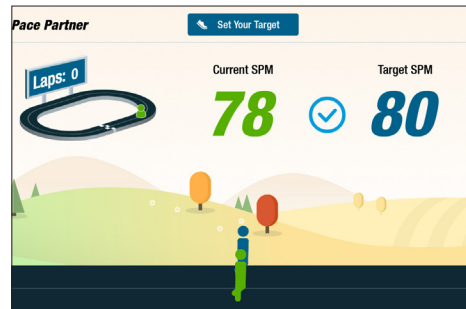

NuStep Charts

Displays workout performance metrics: *Pace (SPM)*, *Watts*, *Load*, or *METs* over time.

To toggle between charts, tap on desired metric tab. The active metric tab is highlighted in blue.

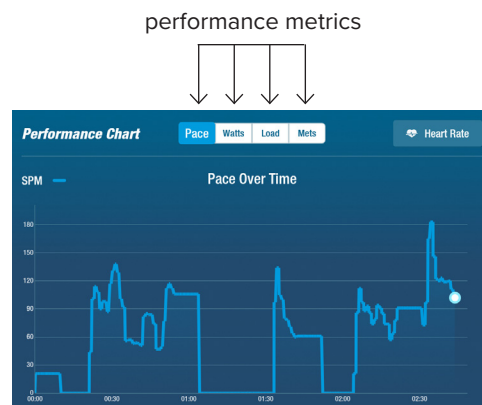

Display Screens

Trail Runner

Plays videos of scenic running trails to engage users as they work out. To start:

1. Tap to select desired video. →
2. Begin stepping to start video.

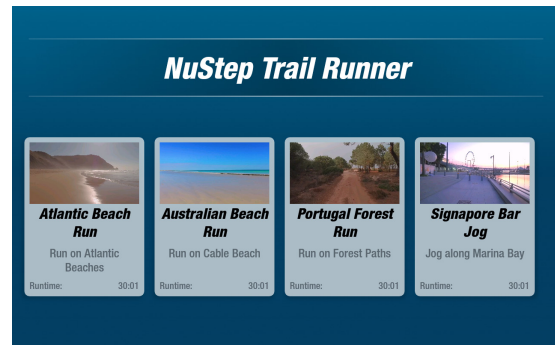

To return to the *Trail Runner* menu:

1. Tap screen, the title bar drops down.
2. Tap on the *Back* button.

All video, audio and other content included in Trail Runner and other NuStep apps is protected under United States and international copyright laws. No right is granted to use the video, audio or other content in any manner other than as presented for viewing in NuStep Products.

Metric screen

The Metric screen displays the following information and controls:

- Reset** button (top left)
- seat position** indicator (top center)
- Home** button (top center)
- User Settings** button (top right)
- System Settings** button (top right)
- Elapsed Time**: 00:13
- Level**: 01 +
- Heart Rate**: Connect button
- Calories**: 0
- SPM**: 0
- METs**: 1.3
- Total Steps**: 17
- Miles**: 0.01
- Watts**: 0

Annotations for the Metric screen:

- Tap to reset workout or to apply changes in default settings. (points to Reset button)
- Tap to return to Home screen. (points to Home button)
- Tap to open User Settings. (points to User Settings button)
- Tap to open System Settings. (points to System Settings button)
- Load level: tap (-) or (+) to adjust. (points to the Level 01 + indicator)
- workout metrics (points to the bottom row of metrics)

Pause Function

The T6 has a 3-minute console shutdown function. If a user stops stepping and does not resume stepping within three minutes, the console resets.

Before the console shuts down, the user can extend the pause (e.g., for interval training) for an additional 15 minutes. At this point, the user can also view a summary of their workout performance or end their workout session.

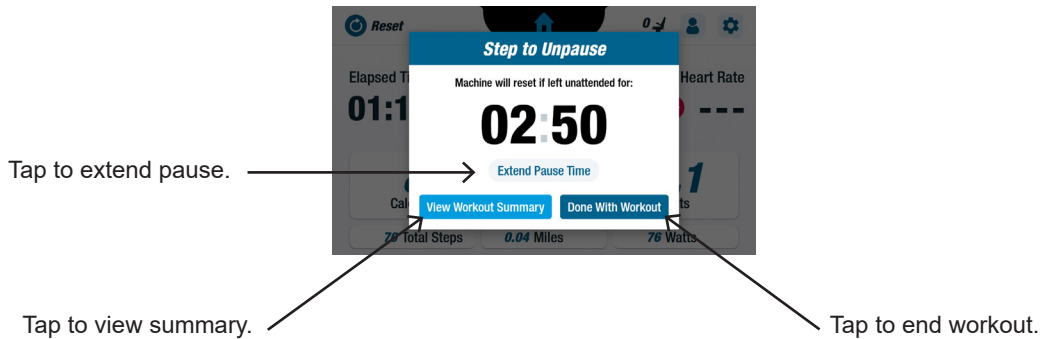

After reviewing the summary, users can return to their workout, end their workout, or export their workout summary to a USB drive (see page 22 for instructions).

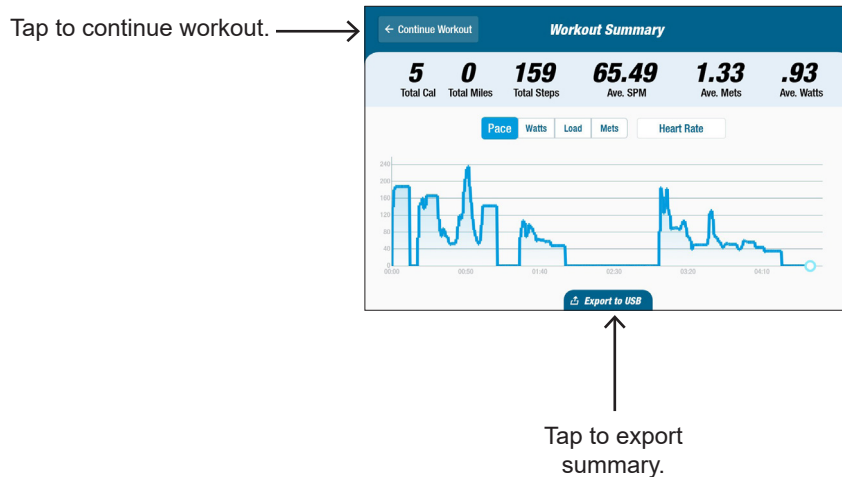

System Settings

System Settings

Use to adjust volume and screen brightness, change default settings, view diagnostics, change metric configuration, view regulatory and software information.

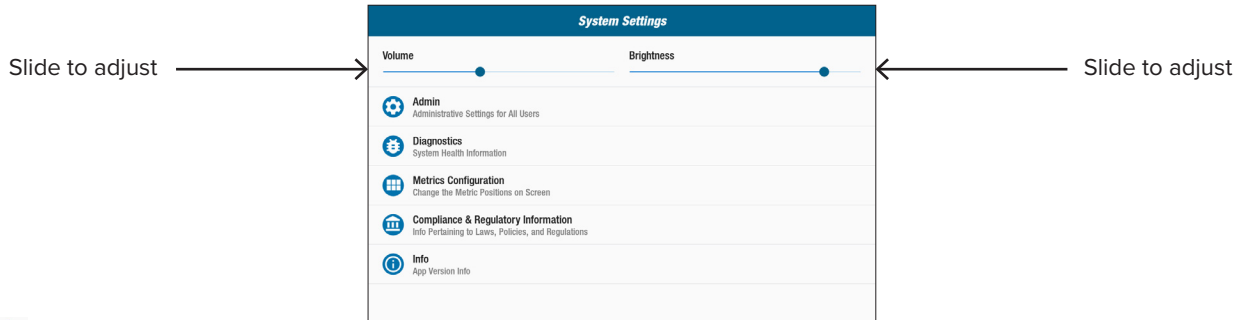

Admin

Use to change default settings (age, weight, gender). Changes made to the default settings are global. Once the Admin screen opens, a password* is required to change default settings. To enter password:

1. Tap screen to open numeric keyboard.
2. Enter password, tap *Submit*.
3. Tap  icon to close keyboard.

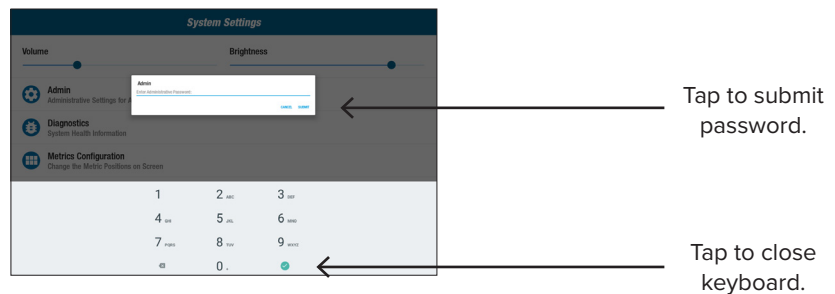

In the Admin screen:

1. Tap into default fields and enter new default settings.
2. Tap *Submit* to apply changes.

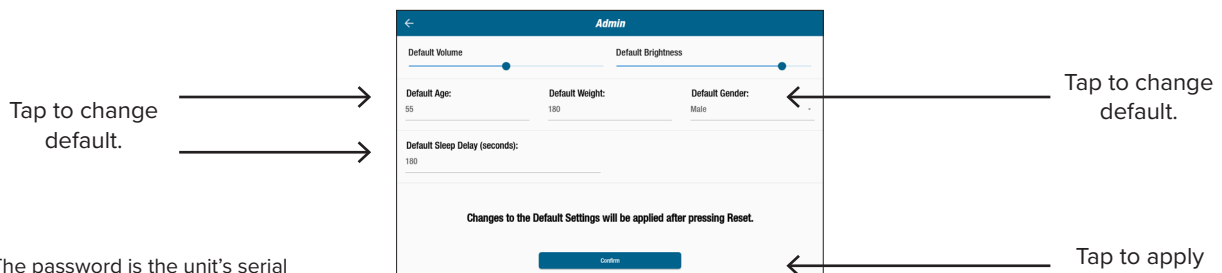

*The password is the unit's serial number entered in reverse order.

System Settings

3. Go to the *Metric* screen.
4. Tap  **Reset** to open the *Reset Workout* screen.
5. Tap **Reset** to apply changes.

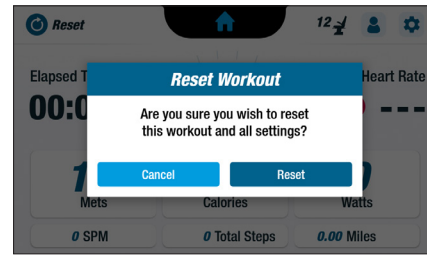

Diagnostics

The diagnostics screens display live and historical data for service technicians or those responsible for equipment maintenance. The *Historical and Versioning* screen requires a password to access (see previous page).

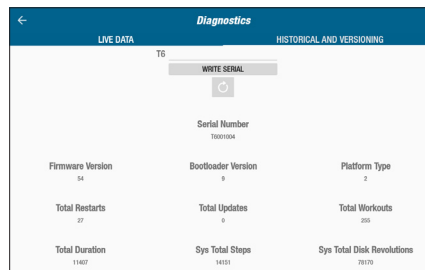

Metrics Configuration

Users may change which metric units are displayed on the metric screen. The top row displays the current metric configuration. To change:

1. Tap on a current metric unit to highlight.
2. Tap on a metric unit for the highlighted slot.
3. Tap *Confirm* to apply change.

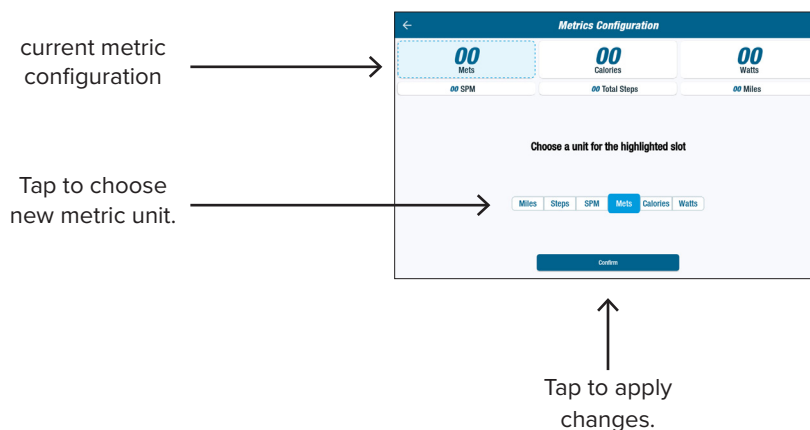

User Settings

User Configuration

Users can create and save a profile with their own settings. To change:

1. Tap screen to open numeric keyboard.
2. Enter age, weight and select sex.

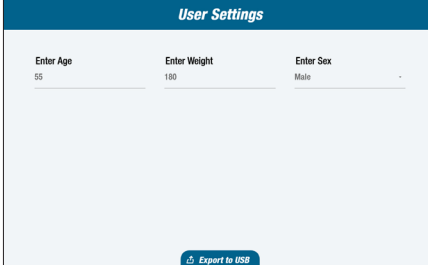

The screenshot shows a mobile application interface titled "User Settings". It features three input fields: "Enter Age" with the value "55", "Enter Weight" with the value "180", and "Enter Sex" with the value "Male". At the bottom center, there is a blue button labeled "Export to USB".

Exporting User Profile Data

Users can export their profile data to a USB drive at any time.

To export:

1. Insert USB drive into the USB port on the back of the display console.
2. Tap  on the *Metric* screen to open the *User Settings* screen.
NOTE: Skip this step if the profile screen launches automatically.
3. Tap *Export to USB* tab at the bottom of the screen.



Tap to open
User Settings.

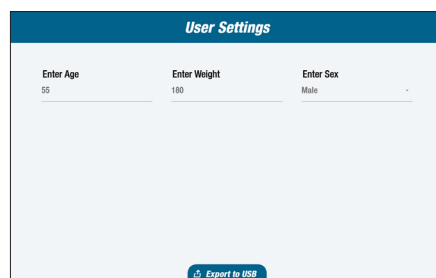
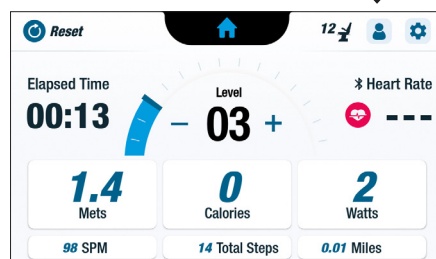

Tap to export
profile data.

Exporting Workout Summary

Users can export their workout summary to a USB drive. The summary is saved in a PDF format.

NOTE: Before working out, insert USB drive into the USB port on the back of the console.

At the end of a workout (when the user has stopped stepping) the *Step to Unpause* screen opens.

1. Tap *View Workout Summary*.

NOTE: Do not tap Done With Workout as this ends the exercise session and resets the machine. It does not allow the user to export their workout summary.

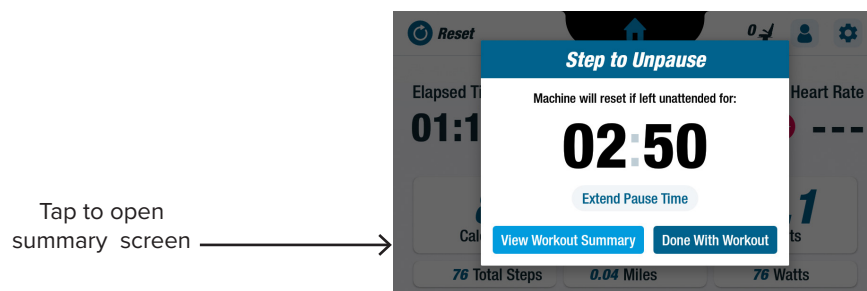

2. From the *Workout Summary* screen, tap *Export to USB*.

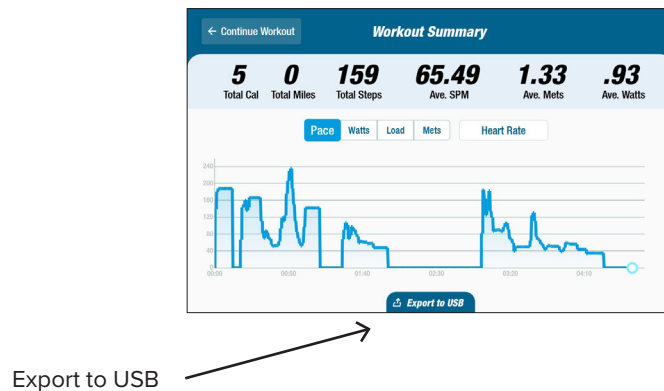

Tap OK to close.

Preventive Maintenance

Preventive Maintenance Intervals

Although your T6 is designed to be maintenance free, we recommend a few tasks to increase the useful life of your equipment. Please follow the recommended preventive maintenance intervals shown below. These are estimated intervals and you may need to increase or decrease the frequency of preventive maintenance depending on your actual use.

ITEM	TASK	FREQUENCY
Arms, Handles and Grips	* Clean	Weekly
Console	* Clean	Weekly
Covers and Frame	* Clean	Weekly
Seat	* Clean	Weekly
* Use a non-abrasive spray cleaner and a soft cloth to clean the NuStep.		

T6 Serial Number Information

Location on the product:

The serial number is located on the right side of the rear support cover.

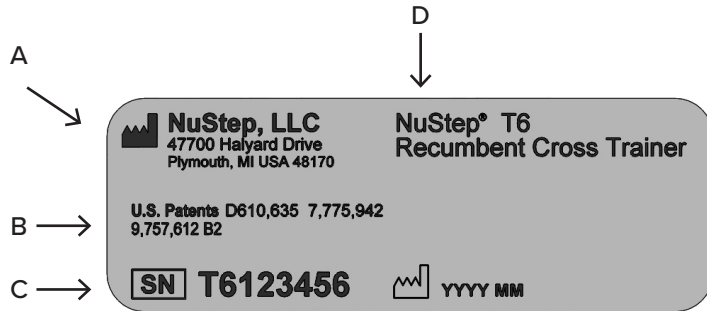

A	Manufacturer's name and address
B	Patent protection for the product
C	Serial number and date of manufacture
D	Model number and description of product

T6 Regulatory Information

Location on the product:

The regulatory information is located on the right side of the rear support cover.

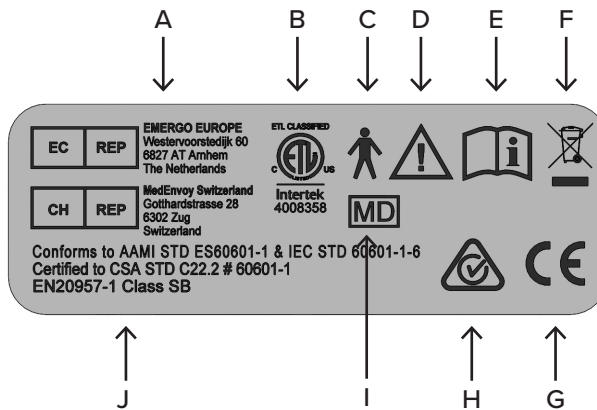

A	European authorized representatives
B	Nationally Recognized Test Lab Mark
C	Type B applied part for electrical safety
D	Attention read accompanying documents
E	Consult the user manual before use
F	WEEE Directive Mark
G	CE Mark
H	RCM
I	Medical device
J	Standards

Label content may vary depending on NuStep model version.

Obtaining Customer Service and Parts

STEP 1 - Identify the problem.

If you did not experience the problem, speak with the person who did to understand the nature of the problem.

STEP 2 - Verify the problem.

Inspect the cross trainer. Determine if a new part is required to correct the problem. Figures and parts lists are available on the NuStep web site.

STEP 3 - Contact NuStep customer service.

So that our product specialists can better assist you, please have a complete description of the problem and the serial number of the unit (see preceding page for location of serial number on the T6).

NuStep product specialists are available via e-mail or phone at:

Email: support@nustep.com

Phone: 800-322-2209 (US)
 734-769-3939

Web: NUSTEP.COM

For customers outside of the US and Canada that require customer service, please contact your local NuStep distributor.

T6 Warranty

To view your warranty online, go to: NUSTEP.COM



If you have any questions about your warranty, please contact customer service at: 800-322-2209 or visit support@nustep.com.

For customers outside of the US and Canada, please contact your local NuStep distributor for warranty details.

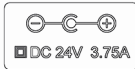
Technical Data

USB A Port	USB port is for flash drive use only. Some flash drives may not be compatible with the T6 USB port. Do not connect external devices to this port with USB cables.
USB C Port	Connection for service only.
Ethernet Port	Connection for local network only. Do not connect the T6 to internet. Use port to connect to IEC 60601-1 compliant equipment only. Use IEC 60601-1 compliant in-line network isolator when connecting to non-medical equipment.
3.5 mm Audio Jack	Connection for passive earphones and headphones with 3.5 mm male jack only.
Standards	ANSI/AAMI ES60601-1, CAN/CSA-C22.2 No. 60601-1, IEC/EN 60601-1, IEC/EN 60601-1-2
Eddy current resistance system	The T6 features a speed dependent eddy current resistance system that is dependent on workload level selected, the user step rate and the user step length. Range: 0 - 1400 watts
Stepping Action	The T6 features dependent stepping action with up to 8.5" (22 cm) stepping range.
Watts Testing Parameters	Displayed watt values represent the energy consumption rate of the user. They are calculated in real-time utilizing an algorithm based on mechanical parameters of the machine and a measured average ride style. The significant mechanical parameters that influence the displayed watt values include the inertia of the machine's moving components, the load level selected by the user, and the rotational velocity of the eddy current disk. Validation testing of the displayed watt values was performed by comparing said value and the actual measured mechanical power produced by multiple users. Displayed watt values are independent of any physiological or anatomical parameter possessed by the user.
AC Adapter	<p>Model AUTEC POWER SYSTEMS DT-M090-240-U-NSP or Model GlobTek TR9KI3750CCP-IM(R6B)</p> <p>Output 24V dc @ 3.75A 90W Max. Input 100-240V~50-60Hz, 1.5A</p> <p>The T6 must only be supplied at safety extra low voltage corresponding to the marking on the product.</p> 

Safety Notifications

TYPE / DEGREE OF PROTECTION	CLASSIFICATION / IDENTIFICATION/ WARNINGS	SYMBOL
Type of protection against electric shock	Class II equipment	
The degree of protection against electric shock	Type B applied part	
The degree of protection against the ingress of liquids	Not protected	N/A
The degree of safety in the presence of a flammable anesthetic mixture with air or with oxygen or nitrous oxide	Not suitable	N/A
The mode of operation	Continuous	N/A
Information regarding potential electromagnetic or other interference and advice regarding avoidance	The NuStep T6 Recumbent Cross Trainer uses electromagnetic and RF energy only for its internal function. Therefore, its EMC and RF emissions are very low and are not likely to cause any interference in nearby electronic equipment.	N/A
EMC warnings and tables required by IEC 60601-1-2	See EMC tables.	N/A

Safety Notifications

TYPE / DEGREE OF PROTECTION	CLASSIFICATION / IDENTIFICATION / WARNINGS	SYMBOL
<p>ID of any risks associated with the disposal of waste products, residues, including disposal of the equipment itself at the end of its useful life.</p>	<p>The NuStep T6 Recumbent Cross Trainer equipment contains electronic circuit assemblies and a coin cell battery that may require compliance with specific local disposal or recycling procedures.</p>	
<p>The specification of the environmental conditions of transport and storage (also marked on the outside of the packaging).</p>	<p>The NuStep T6 Recumbent Cross Trainer equipment can be:</p> <p>a) safely transported and stored in these conditions -10° to 50°C; ≤ 95% non-condensing humidity; 20 to 107 kPa</p> <p>b) operated in these conditions 5° to 40°C; ≤ 85% non-condensing humidity; 60 to 107 kPa.</p>	<p>N/A</p>
<p>Indication that the equipment is energized.</p>	<p>When the T6 is plugged in and not in use, the stand-by power indicator on the front of the console remains on.</p>	<p>N/A</p>

EMC Tables

Guidance and manufacturer's declaration – electromagnetic emissions		
<p>The NuStep model T6 is intended for use in the electromagnetic environment specified below. The customer or the user of the NuStep model T6 should assure that it is used in such an environment. The product does not include essential performance features and functions.</p>		
Emissions test	Compliance	Electromagnetic environment – guidance
RF emissions CISPR 11	Group 1	The NuStep model T6 uses RF energy only for its internal function. Therefore, its RF emissions are very low and are not likely to cause any interference in nearby electronic equipment.
RF emissions CISPR 11	Class B	The NuStep model T6 is suitable for use in all establishments.
Harmonic emissions IEC 61000-3-2	Not applicable	
Voltage fluctuations/ flicker emissions IEC 61000-3-3	Not applicable	

EMC Tables

Table 2 – Guidance and MANUFACTURER’S declaration – electromagnetic IMMUNITY – for all ME EQUIPMENT and ME SYSTEMS

Guidance and manufacturer’s declaration – electromagnetic immunity			
The NuStep model T6 is intended for use in the electromagnetic environment specified below. The customer or the user of the NuStep model T6 should assure that it is used in such an environment.			
Immunity test	IEC 60601 Test level	Compliance level	Electromagnetic environment – guidance
Electrostatic discharge (ESD) IEC 61000-4-2	± 8 kV contact ± 15 kV air	± 4 kV contact ± 8 kV air (See note 1)	Floors should be wood, concrete or ceramic tile. If floors are covered with synthetic material, the relative humidity should be at least 30%.
Electrical fast transient/burst IEC 61000-4-4	± 2kV for power supply lines	± 2kV for power supply lines	Mains power quality should be that of a typical commercial or hospital environment.
Surge IEC 61000-4-5	± 1 kV differential mode ± 2 kV common mode	± 1 kV differential mode ± 2 kV common mode	Mains power quality should be that of a typical commercial or hospital environment.
Voltage dips, short interruptions and voltage variations on power supply input line IEC 61000-4-11	0 % UT; 0,5 cycle 0 % UT; 1 cycle 70 % UT; 25/30 cycles 0 % UT; 250/300 cycle	0 % UT; 0,5 cycle 0 % UT; 1 cycle 70 % UT; 25/30 cycles 0 % UT; 250/300 cycle	Mains power quality should be that of a typical commercial or hospital environment. If the user of the NuStep® T6 Recumbent Cross Trainer requires continued operation during power mains interruptions, the NuStep® T6 Recumbent Cross Trainer would be powered from its internal batteries.
Power frequency (50/60 Hz) Magnetic field IEC 61000-4-8	30 A/m	30 A/m	Power frequency magnetic fields should be at levels characteristic of a typical location in a typical commercial or hospital environment.
NOTE 1 Higher levels of ESD will have no impact upon basic safety or essential performance. (See: Guidance and manufacturer’s declaration – electromagnetic emissions) NOTE 2 U_T is the a.c. mains voltage prior to application of the test level.			

EMC Tables

Table 3 – Guidance and MANUFACTURER’S declaration – electromagnetic IMMUNITY – for ME EQUIPMENT and ME SYSTEMS that are not LIFE-SUPPORTING

Guidance and manufacturer’s declaration – electromagnetic immunity			
The NuStep model T6 is intended for use in the electromagnetic environment specified below. The customer or the user of the NuStep model T6 should assure that it is used in such an environment.			
IMMUNITY test	IEC 60601 TEST LEVEL	Compliance level	Electromagnetic environment – guidance
Conducted RF IEC 61000-4-6 Radiated RF IEC 61000-4-3	3 Vrms 150 kHz to 80 MHz 3 V/m 80 MHz to 2,7 GHz	3 Vrms 3 V/m	Portable and mobile RF communications equipment should be used no closer to any part of the NuStep model T6, including cables, than the recommended separation distance calculated from the equation applicable to the frequency of the transmitter. Recommended separation distance Not applicable $d = 1.2 \sqrt{P}$ 80 MHz to 800 MHz $d = 2.3 \sqrt{P}$ 800 MHz to 2,7 GHz Where P is the maximum output power rating of the transmitter in watts (W) according to the transmitter manufacturer and d is the recommended separation distance in meters (m). Field strengths from fixed RF transmitters, as determined by an electromagnetic site survey, ^a should be less than the compliance level in each frequency range. ^b Interference may occur in the vicinity of equipment marked with the following symbol: 
NOTE 1 At 80 MHz and 800 MHz, the higher frequency range applies. NOTE 2 These guidelines may not apply in all situations. Electromagnetic propagation is affected by absorption and reflection from structures, objects and people. NOTE 3 The product complies with IEC 60601-1-2 clause 8.10 table 9 for immunity to proximity fields from RF wireless communications equipment			
a. Field strengths from fixed transmitters, such as base stations for radio (cellular/cordless) telephones and land mobile radios, amateur radio, AM and FM radio broadcast and TV broadcast cannot be predicted theoretically with accuracy. To assess the electromagnetic environment due to fixed RF transmitters, an electromagnetic site survey should be considered. If the measured field strength in the location in which the NuStep model T6 is used exceeds the applicable RF compliance level above, the NuStep model T6 should be observed to verify normal operation. If abnormal performance is observed, additional measures may be necessary, such as re-orienting or relocating the NuStep model T6. b. Over the frequency range 150 kHz to 80 MHz, field strengths should be less than 3 V/m.			

US FCC Compliance & IEC/EN 55011 Compliance

US FCC Compliance Statement:

Note: This equipment has been tested and found to comply with the limits for a Class B Digital Device, pursuant to Part 15 of the FCC Rules. These limits are designed to provide reasonable protection against harmful interference in a residential installation. This equipment generates, uses and can generate radio frequency energy and, if not installed and used in accordance with the installation instructions, may cause harmful interference to radio communications. However, there is no guarantee that interference may not occur in a particular installation. If the equipment causes harmful interference to radio or television reception, which can be determined by turning this equipment off and on, the user is encouraged to try and correct the interference by one or more of the following measures:

- Reorient or relocate the receiving antenna
- Increase the separation between the equipment and the receiver
- Connect the equipment into an outlet on a circuit that is different from that to which the receiver is connected
- Consult the dealer or an experienced radio/TV technician for help

IEC/EN 55011 Compliance Statement:

This device complies with IEC/EN 55011, Group 1, Class B. Group 1 contains all ISM equipment in which there is intentionally generated and/or used conductively coupled radio-frequency energy which is necessary for the internal functioning of the equipment itself. Class B equipment is suitable for use in domestic establishments and in establishments directly connected to the low voltage power supply network which supplies buildings used for domestic purposes.

Trademarks

The Bluetooth® word mark and logos are registered trademarks owned by the Bluetooth SIG, Inc. and any use of such marks by NuStep,LLC is under license. Other trademarks and trade names are those of their respective owners.

Intended Purpose and Use

Intended Purpose

The NuStep® recumbent cross trainer is an apparatus for therapeutic exercise.

Intended Use

The recumbent cross trainer may be used to improve aerobic fitness, strength and endurance. The recumbent cross trainer includes the following features and functionality to assist individuals who have mobility or cognitive impairments:

- swivel seat
- arm rests
- StrideLock®
- stabilization straps
- seated exercise position
- contralateral exercise motion

Under the guidance and supervision of a physician and/or a physical therapist, the recumbent cross trainer may be used by cardiac, cardiovascular, and physical therapy patients for therapeutic exercise. The physician and/or physical therapist responsible for the patient's care shall assess the benefits and risks of using the recumbent cross trainer for therapeutic exercise prior to each use to ensure that the chosen form of use is appropriate and reasonable.

Intended Operator

The intended operators are qualified healthcare professionals who have been trained on the information provided in the recumbent cross trainer user manual. The patient or exerciser is not the intended operator, but the intended operator may allow the patient or exerciser to operate the recumbent cross trainer according to the instructions in the product user manual. The operation of the recumbent cross trainer remains the responsibility of the intended operator at all times.

Intended Location

The recumbent cross trainer is suitable for use in the following settings:

- physical therapy clinics
- cardiopulmonary rehabilitation clinics
- sports medicine clinics
- general wellness centers



EMERGO EUROPE

Westervoortsedijk 60,
6827 AT Arnhem
The Netherlands

Note:

Any serious incident that has occurred in relation this product should be reported to NuStep, LLC, the above listed European Authorized Representative, and the EU competent authority of the member state in which the user is established. The expected service life of this product is ten years.

NuStep, LLC
47700 Halyard Drive
Plymouth, MI 48170
U.S.A.
800-322-2209
734-769-3939
www.nustep.com



The information in this manual is the most current at the time of printing. Due to our commitment toward continuous improvement, specifications and descriptions are subject to change without notice. No part of this manual may be reproduced or transmitted in any form or by any means, electronic or mechanical, for any purpose without the express written permission of NuStep, LLC.

© Copyright April 2021 by NuStep, LLC.

NuStep® and Transforming Lives® are registered trademarks of NuStep, LLC.

Manual PN 52390-01 T6 User Manual, Rev E

